

DAU SURFACE

D92017

GENERAL

Series: Dau _____
 Brand: Milan _____
 Division: Design _____
 Mounting Type: Surface _____
 Mounting Location: Ceiling _____
 Subcategory: Pendant _____

PHYSICAL

Shape: Abstract _____
 Length (mm): 520 _____
 Length (in): 20 1/2 _____
 Width (mm): 110 _____
 Width (in): 4 5/16 _____
 Height (mm): 254 _____
 Height (in): 10 _____
 Weight (kg): 1.4 _____
 Weight (lbs): 3 _____
 Fixture Material: Aluminum _____

ELECTRICAL

Number of Lamps: 3 _____
 Lamp Type: LED Retrofit _____
 Lamp Shape: MR16 _____
 Bulb Included: Bulb Not Included _____
 Total Output Wattage (W): 15 _____
 Max. Wattage Per Lamp (W): 5 _____
 Lamp Base: GU10 _____
 Input Voltage (V): 120 _____

LED

Delivered Lumen Range: 500 - 999 lm _____

OPTICAL

RATINGS AND CERTIFICATIONS

Certified By: CSA Certified to UL and CSA Standards _____
 IP rating: IP20 _____

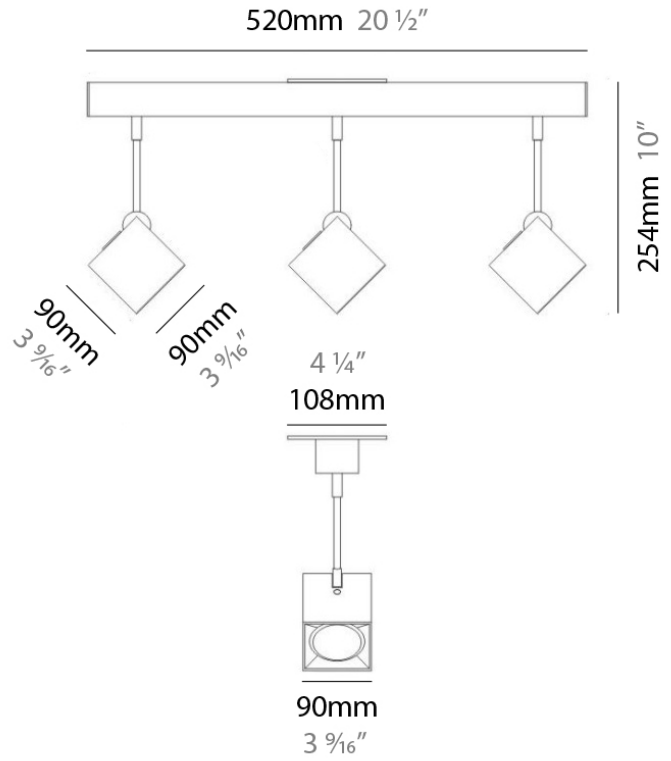

PROJECT	
TYPE	
NOTES	
QUANTITY	
DATE	

DAU SURFACE

D92018

GENERAL

Series: Dau
 Brand: Milan
 Division: Design
 Mounting Type: Surface
 Mounting Location: Ceiling
 Subcategory: Pendant

PHYSICAL

Shape: Abstract
 Length (mm): 750
 Length (in): 29 1/2
 Width (mm): 110
 Width (in): 4 5/16
 Height (mm): 254
 Height (in): 10
 Weight (kg): 2.04
 Weight (lbs): 4.5
 Fixture Material: Aluminum

ELECTRICAL

Number of Lamps: 4
 Lamp Type: LED Retrofit
 Lamp Shape: MR16
 Bulb Included: Bulb Not Included
 Total Output Wattage (W): 20
 Max. Wattage Per Lamp (W): 5
 Lamp Base: GU10
 Input Voltage (V): 120

LED

Delivered Lumen Range: 1000 - 1999 lm

OPTICAL

RATINGS AND CERTIFICATIONS

Certified By: CSA Certified to UL and CSA Standards
 IP rating: IP20

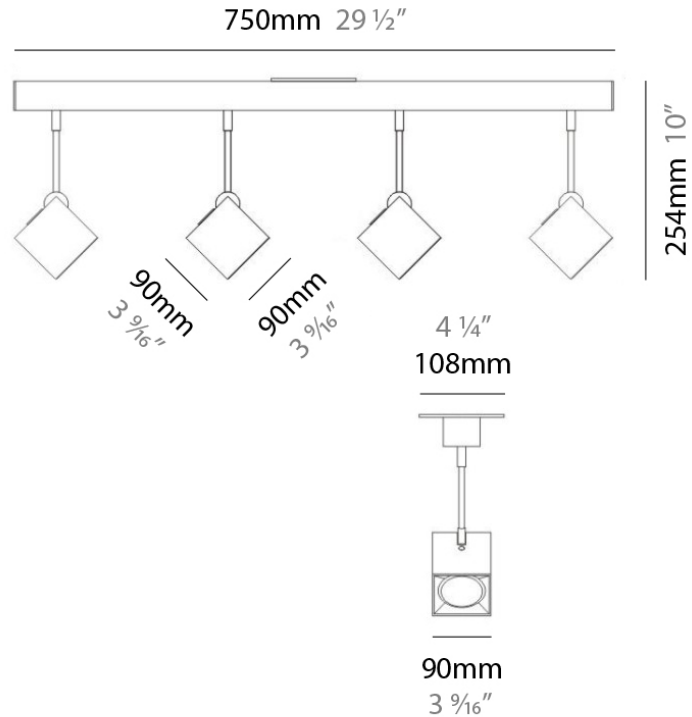

DAU SURFACE

D92020

PROJECT	
TYPE	
NOTES	
QUANTITY	
DATE	

GENERAL

Series: Dau
 Brand: Milan
 Division: Design
 Mounting Type: Surface
 Mounting Location: Ceiling
 Subcategory: Pendant

PHYSICAL

Shape: Square
 Length (mm): 300
 Length (in): 11 3/4
 Width (mm): 300
 Width (in): 11 3/4
 Height (mm): 254
 Height (in): 10
 Weight (kg): 3.27
 Weight (lbs): 7.2
 Fixture Material: Aluminum

ELECTRICAL

Number of Lamps: 4
 Lamp Type: LED Retrofit
 Lamp Shape: MR16
 Bulb Included: Bulb Not Included
 Total Output Wattage (W): 20
 Max. Wattage Per Lamp (W): 5
 Lamp Base: GU10
 Input Voltage (V): 120

LED

Delivered Lumen Range: 1000 - 1999 lm

OPTICAL

RATINGS AND CERTIFICATIONS

Certified By: CSA Certified to UL and CSA Standards
 IP rating: IP20

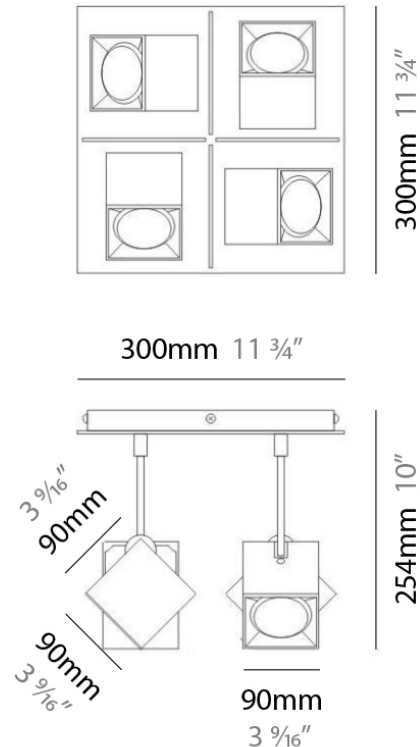

DAU SURFACE

D92028

GENERAL

Series: Dau
 Brand: Milan
 Division: Design
 Mounting Type: Surface
 Mounting Location: Ceiling
 Subcategory: Spots

PHYSICAL

Shape: Square
 Length (mm): 110
 Length (in): 4 ⁵/₁₆
 Width (mm): 110
 Width (in): 4 ⁵/₁₆
 Height (mm): 254
 Height (in): 10
 Weight (kg): 0.9
 Weight (lbs): 2
 Fixture Material: Metal

ELECTRICAL

Number of Lamps: 1
 Lamp Type: LED Retrofit / Halogen
 Lamp Shape: MR16
 Bulb Included: Bulb Not Included
 Total Output Wattage (W): 5
 Max. Wattage Per Lamp (W): 5
 Lamp Base: GU10
 Input Voltage (V): 120

LED

Delivered Lumen Range: 100 - 499 lm

OPTICAL







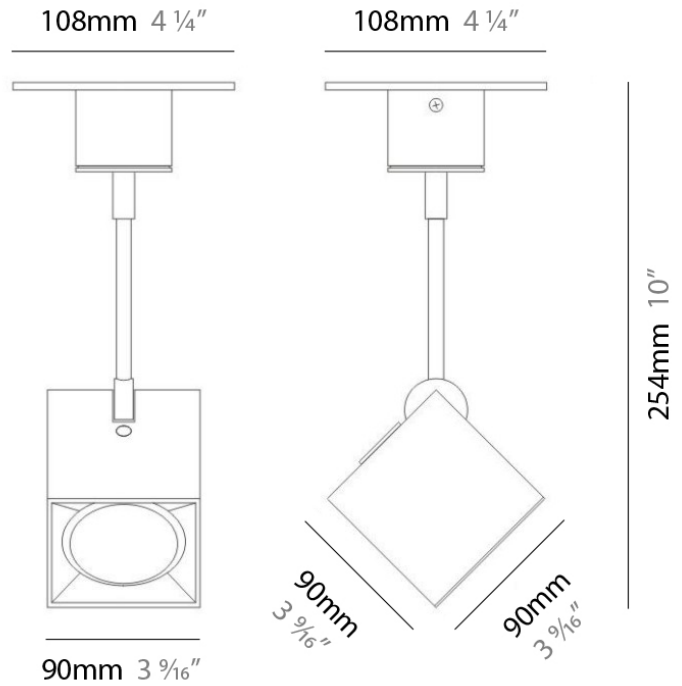





























































RATINGS AND CERTIFICATIONS

Certified By: CSA Certified to UL and CSA Standards
 IP rating: IP20

PROJECT	
TYPE	
NOTES	
QUANTITY	
DATE	













LEGEND

	floor-mounted		pivotal		special LED (upon request) RGB, RGBW, tunable, gold+, meat+, art+, fashion+
	wall and ceiling: recessed and surface mounted		rotating		warm dim / natural dimming LED
	ceiling-mounted and wall-mounted		illuminate tilted		rechargeable battery powered
	wall-mounted		color of suspension cable		fixture with natural vivid LED (upon request)
	omni-directional light distribution		length of suspension cable		color rendering index
	direct light distribution		reflector degree selection		color temperature
	direct/indirect light distribution		super spot		lumen (luminous flux)
	indirect light distribution		lens		efficacy (lumens per watt)
	asymmetric light distribution		lens pack		Unified Glare Rating (UGR) range from 5-40
	aura light distribution		shine ring		marine grade (AISI 316 stainless steel)
	round wall or ceiling cut-out		integrated shine ring with diffuser		walk on
	square wall or ceiling cut-out		free individual colors 01-29		drive on
	the supplied jig specifies the cutout dimensions		individual colors: 00 (free of charge), 01-25 (extra charge)		Dark Sky Compliance
	minimum distance (meters) lamp - object		luminaire part to be colored (F1)		Americans with Disabilities Act (less than 4" off the wall located between 27"-84" from floor)
	recessed depth		luminaire part to be colored (F2)		lamp protected against explosion
	ceiling thickness in mm		luminaire part to be colored (F3)		blown glass using traditional methods by master glass blower
	ceiling thickness selection		luminaire part to be colored (F4)		acoustic material
	dimmable DP (phase), DV (0-10V), DD (dali), DS (step-dim)		luminaire part to be colored (F5)		protection class I, protection insulation
	included or excluded LED driver/transformer/control gear		color of 3-circuit adaptor		protection class II, protection insulation
	separately switchable		indirect diffuser		ETL Certified to UL and CSA Standards
	sensor		direct diffuser		UL Certified to UL and CSA Standards
	remote control		ball-proof (upon request)		CSA Certified to UL and CSA Standards
	available upon request		accessory		Certified for North American Standards

IP RATING

	protected against ingress of solid bodies greater than 12.5mm (finger)
	protected against ingress of solid bodies greater than 2.5mm protected against sprays of water up to 60 degrees from the vertical (rain)
	protected against ingress of solid bodies greater than 1mm (wire) no protection against the ingress of moisture
	protected against ingress of solid bodies greater than 1mm (wire) protected against sprays of water up to 60 degrees from the vertical (rain)
	protected against ingress of solid bodies greater than 1mm (wire) protected against water splashed from all directions
	protected against limited ingress of dust (wet rooms/covered outdoor areas) protected against water splashed from all directions
	protected against ingress of dust protected against jets of water
	protected against ingress of dust protected against powerful jets of water or heavy seas
	protected against ingress of dust protected against immersion of water between 15cm - 1m for 30 minutes
	protected against ingress of dust protected against immersion of water under pressure for long periods

IK RATING

	protected against 0.14 joules impact (equivalent to 0.25kg mass dropped from 56mm above the surface)
	protected against 0.2 joules impact (equivalent to 0.25kg mass dropped from 80mm above the surface)
	protected against 0.35 joules impact (equivalent to 0.25kg mass dropped from 140mm above the surface)
	protected against 0.5 joules impact (equivalent to 0.25kg mass dropped from 200mm above the surface)
	protected against 0.7 joules impact (equivalent to 0.25kg mass dropped from 280mm above the surface)
	protected against 1 joules impact (equivalent to 0.25kg mass dropped from 400mm above the surface)
	protected against 2 joules impact (equivalent to 0.5kg mass dropped from 400mm above the surface)
	protected against 5 joules impact (equivalent to 1.7kg mass dropped from 300mm above the surface)
	protected against 10 joules impact (equivalent to 5.0kg mass dropped from 200mm above the surface)
	protected against 20 joules impact (equivalent to 5.0kg mass dropped from 400mm above the surface)